

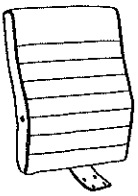

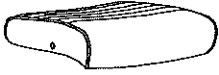

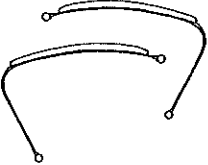

6960

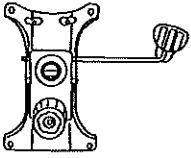
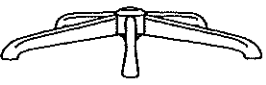
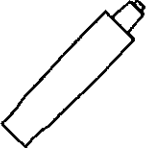
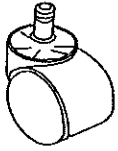

6960

(1)x1  Back	(2)x1  Seat
(3)x1 L/R  Right & Left Arm	(4)x1  Mechanism
(5)x1  Base	(6)x1  Gas Lift

(7)x5  Casters	
(A)x4  M8*45 ARM SCREW	
(B)x4  M8*22 MECHANISM SCREW	
(C)x4  M6*30 L-BAR SCREW	
(D)x4  ARM CAP	
(E)x1  ALLEN KEY	

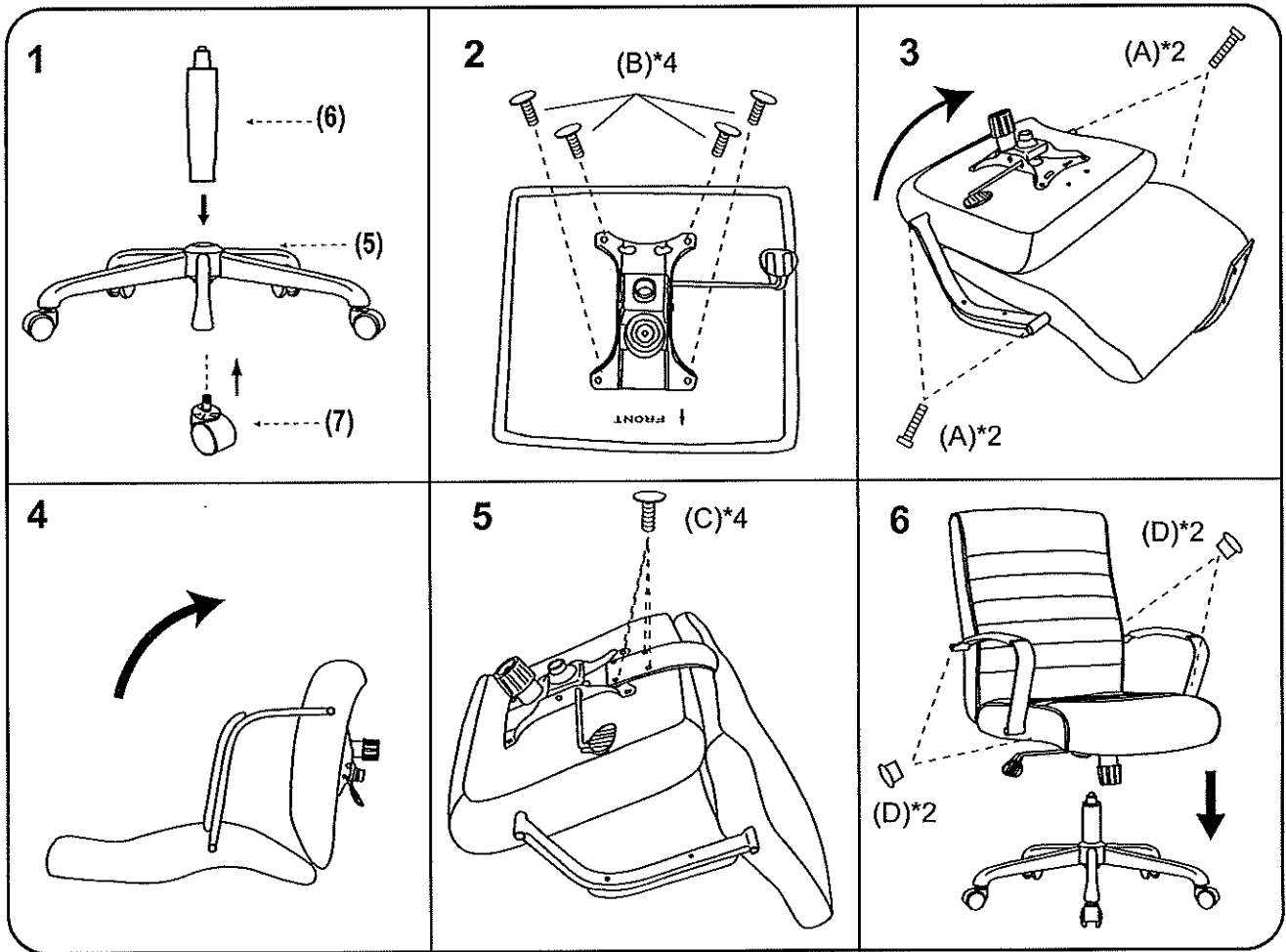

Insert and loosely tighten all screws. When assembly is completed, fully tighten all screws before using. This chair is only intended for sitting. Any other use will void the warranty.